



# ITM Catalogue/Catálogo 2021

**PPE & Safety Supplies / Suministros de Seguridad y Protección Personal**





## Gown

Coverall  
Coverall, Split  
Type 4/5/6 Coverall  
Type 5/6 Coverall  
Lab coat  
Isolation Gown  
PE Visitor Coat  
PE Smock  
CPE Thumb Hook Gown

## Trajes de Protección

Overoles  
Overol, dividido  
Overol tipo 4/5/6  
Overol tipo 5/6  
Traje de laboratorio  
Traje de aislamiento  
Traje de visitante  
Guardapolvo  
Traje CPE con gancho para el pulgar

## Coverall - Overol

Colors Available:  white  blue  green  dark blue  red



### With hood

Feature: Front zipper, with elastic at waist, cuff and ankle, without boot cover

Code	N310	N311	N312
Description	Coverall, with hood	Coverall, with hood, with zipper flap	Coverall, with hood PE coated
Size	S-XXL	S-XXL	S-XXL
Material	PP	PP	PP+PE
Packing	10x5	10x5	10x5

### Con capucha

Característica: Cremallera frontal, con elástico en cintura, puños y tobillo, sin cubrebotas

## Coverall, Split - Overol, dividido

Colors Available:  white  blue  dark blue  dark green



Code	N341	N342
Description	Coverall, split, shirt with hood+Pant	Coverall, split, shirt with collar (no hood)+ Pant
Size	S-XXL	S-XXL
Material	PP	PP
Packing	1x50	1x50

## Type 4/5/6 Coverall - Overol tipo 4-5-6

Colors Available:  white  yellow



Code	N326-D
Description	Microporous coverall, high level protection, with hood, with tape seam, conform to type 4/5/6
Size	S-XXXL
Material	PE laminates nonwoven
Packing	1x25

## Type 5/6 Coverall - Overol tipo 5-6

Colors Available:  White  blue



Code	N326-A
Description	SMS coverall, with hood, Conform to type 5/6
Size	S-XXXL
Material	SMS
Packing	1x50

Code	N326-B
Description	Microporous coverall, with hood, conform to type 5/6
Size	S-XXXL
Material	PE laminates nonwoven
Packing	1x50

Code	N326-C
Description	Microporous coverall, with hood, with tape seam, conform to type 5/6
Size	S-XXXL
Material	PE laminates nonwoven
Packing	1x50

# ITM BUSINESS SOLUTIONS

## Lab coat - Traje de Laboratorio

Colors Available: ○ white ● blue ● green ● dark blue ● red



**Feature:**  
With single collar, with elastic cuff or knitted cuff (double collar is available)  
With pockets or without pocket

**Característica:**  
Con cuello sencillo, puño elástico o puño tejido (doble cuello está disponible) Con/sin bolsillos

Code	N313	N315
<b>Description</b>	Lab coat, with 4 press-buttons	Lab coat, with 4 press-buttons
<b>Material</b>	PP	SMS
<b>Packing</b>	10×10	10×10

Code	N314
<b>Description</b>	Lab coat, with 4 velcro fastenings
<b>Material</b>	PP
<b>Packing</b>	10×10

Code	N330
<b>Description</b>	Lab coat, with buttons, with cotton collar, knitted cuff
<b>Material</b>	SMS
<b>Packing</b>	10×10

## Isolation Gown - Traje de Aislamiento

Colors Available: ○ white ● blue ● dark blue ● yellow ● green ● dark green



### With knitted cuff

Code	N302
<b>Description</b>	Isolation gown, with knitted cuff
<b>Size</b>	S-XL
<b>Material</b>	PP
<b>Packing</b>	10×10

### With elastic cuff

Code	N301
<b>Description</b>	Isolation gown, with elastic cuff
<b>Size</b>	S-XL
<b>Material</b>	PP
<b>Packing</b>	10×10

### Other style

Code	N303	N304	N305
<b>Description</b>	Isolation gown, full coated	Isolation gown, half coated (PE coated at front and sleeve), back PP, velcro at neck	Isolation gown, 4 waist belts, velcro at neck
<b>Size</b>	S-XL	S-XL	S-XL
<b>Material</b>	PP+PE	PP+PE	PP
<b>Packing</b>	10×10	10×10	10×10

Any gram, size, material or style are available - Disponibles en cualquier gramo, tamaño, material o estilo.

## PE Visitor Coat - Traje de Visitante

Colors Available: ○ white ● blue



## PE Smock - Guardapolvo

Colors Available: ○ white ● blue ● green ● red ● yellow



## CPE Thumb Hook Gown

Colors Available: ● blue

Traje CPE con gancho para el pulgar



Code	C301	C302
Description	PE visitor coat, without hood, with buttons	PE visitor coat, with hood, with buttons
Material	PE	PE
Packing	1x500	1x500

Code	C303
Description	PE smock, with hood, with pull string, no buttons
Material	PE
Packing	1x500

Code	C305
Description	CPE thumb hook gown
Material	CPE
Packing	1x500

## Patient Gown - Traje de Paciente

Colors Available: ● blue ● dark blue ● green ● dark green



## Short Pant - Pantalón Corto

Colors Available: ○ white ● blue ● green ● dark blue ● dark green ● black



Feature: Used for colonoscopy or endoscopy examination or other applications  
Característica: se utiliza para colonoscopia o examen de endoscopia u otras aplicaciones

Code	N318	N319	N320
Description	Patient gown, short sleeve	Patient gown, without sleeve	Patient gown, for child, short sleeve
Material	PP	PP	PP
Packing	10x10	10x10	10x10

Code	N350	N351
Description	Short pant with slit	Short pant with velcro and flap
Size	L, XL	L, XL
Material	PP	PP
Packing	10x10	10x10

Any gram, size, material or style are available - Disponibles en cualquier gramo, tamaño, material o estilo.

Sales@ITMbusinessSolutions.ca

Ventas@ITMbusinessSolutions.ca



## Cap

- Mob Cap
- Bouffant Cap
- Peaked Cap
- Work Cap
- Astro cap, with/without facemask
- Industrial Hood
- Nylon Net Cap
- Chef Cap
- Forage Cap

## Gorros

- Gorro mob
- Gorro bouffant
- Gorro con visera
- Gorro de trabajo
- Gorro Astro, con / sin mascarilla
- Capucha Industrial
- Gorro de Red de Nylon
- Gorro de Chef
- Gorro de Forraje
- Gorro de Cirujano

### Mob Cap - Gorro Mob

Colors Available:  white  blue  green  yellow  red  pink  lake blue



Code	N104	N105	N106	N107	N108
Description	Mob cap, single elastic	Mob cap, single elastic	Mob cap, single elastic	Mob cap, double elastic	Detectable mob cap, double elastic
Size	18"	21"	24"	21"	21"
Material	PP	PP	PP	PP	PP
Packing	100×10	100×10	100×10	100×10	100×10

### Bouffant Cap - Gorro Bouffant

Colors Available:  white  blue  green  yellow  red  spunlace



Code	N101	N102	N103	N145
Description	Bouffant cap	Bouffant cap	Bouffant cap	Bouffant cap
Size	18"	21"	24"	21"
Material	PP	PP	PP	Spunlace
Packing	100×10	100×10	100×10	100×10

### Peaked Cap - Gorro con Visera

Colors Available:  white  blue  green



Code	N116
Description	Peaked cap for both man and woman, size 21"
Material	PP
Packing	100×10

## Work Cap - Gorro de Trabajo

Colors Available:  white  blue  green



Code	N117	N133
Description	Snood cap for woman, with hairnet at back	Work cap for man, without hairnet
Material	PP	PP
Packing	100×10	100×10

## Astro cap, with/without facemask

Colors Available:  white  blue  green

### Gorro Astro, con/sin Mascarilla



Code	N138	N139
Description	Astro cap, without facemask	Astro cap, with 2 ply facemask
Material	PP	PP
Packing	50×10	50×10

## Industrial Hood

Colors Available:  white  blue  green

### Capucha Industrial



Code	N141
Description	Industrial hood
Material	PP
Packing	50×10

## Nylon Net Cap

Colors Available:  white  blue  black

### Gorro de Red de Nylon



Code	C106	C107
Description	Nylon net cap	Nylon net cap
Size	18"	21"
Material	Nylon	Nylon
Packing	100×10	100×10

## Chef Cap - Gorro de Chef

Colors Available:  white



With round top or flat top  
Con tapa redonda o tapa plana

Code	N119	N123
Description	Paper chef cap, height:18/23cm	Viscose chef cap, height:18/23cm
Material	Paper	Viscose
Packing	20×25	20×25

## Forage Cap

Colors Available:  white

### Gorro de Forraje



Code	N135	N136	N137
Description	Paper forage cap, without stripe	Paper forage cap, with colored stripe	Viscose Forage cap, without stripe
Material	Paper	Paper	Viscose
Packing	100×10	100×10	100×10

## Surgeon Cap - Gorro de Cirujano

Colors Available:  white  blue  green  dark blue  spunlace  dark green



Feature: Universal sizes to fit all  
Característica: Tamaño universal

Code	Description	Material	Packing
N109	Surgeon cap, 1ply, with fixed ties	PP	100×10
N110	Surgeon cap, 2ply, with fixed ties	PP	100×10
N112	Surgeon cap, 1ply, with elastic	PP	100×10
N113	Surgeon cap, 1ply, with elastic lattice or wave design	Spunlace	100×10

Code	Description	Material	Packing
N128	SMS surgeon cap, with PP top, 1 ply, with fixed ties	SMS	100×10

Code	Description	Material	Packing
N129	Ultrasonic seam surgeon cap, 1 ply, with elastic	PP	100×10
N130	Ultrasonic seam surgeon cap, 1 ply, with tie	PP	100×10



## Face Mask

- Nonwoven Face Mask
- Dust Mask
- Paper Face Mask
- Beard Cover

## Mascarillas

- Mascarilla no tejida
- Máscara contra el polvo
- Mascarilla de papel
- Cubre Barba

### Face Mask With Shield

Colors Available:  white  blue  green



### Mascarilla con Escudo Protector

Code	Description	Material	Packing
N223	Face mask, with earloops, with shield	PP+filter paper+PP	50×10
N225	Face mask, 3ply, with earloops, with shield, with anti-foggy bar	PP+filter paper+PP	50×10

### Paper Face Mask

Colors Available:  white



### Mascarilla de Papel

Code	Description	Material	Packing
N205	Paper face mask, 1-layer	Paper	100×100
N206	Paper face mask, 2-layers	Paper	100×100



## Nonwoven Face Mask - Mascarilla no tejida

Colors Available:  white  blue  green  printed



Code	Description	Material	Packing
N201	Face mask, 2-layers, with earloops	PP+PP	50×20
N203	Face mask, 3-layers, with earloops	PP +filter paper+PP	50×20
N212	Surgical face mask, 3-layers, with earloops, BFE>99%,risk I	PP +filter paper+PP	50×20
N217	Face mask, with earloops, 3-layers, with embossed LOGO	PP +filter paper+PP	50×20

Code	Description	Material	Packing
N202	Face mask, 2-layers, with ties	PP+PP	50×20
N204	Face mask, 3-layers, with ties	PP +filter paper+PP	50×20
N209	Surgical face mask, 3-layers, with ties, BFE>99%,risk II	PP +filter paper+PP	50×20
N218	Face mask, with ties, 3-layers, with embossed LOGO	PP +filter paper+PP	50×20

## Nonwoven Face Mask - Mascarilla no tejida

Colors Available:  white  blue  green  printed



Code	Description	Material	Packing
N211	Children face mask, with earloops, single color printing	PP+filter paper+PP	50×20
N214	Children face mask, with earloops	PP +filter paper+PP	50×20
N215	Babies face mask, with earloops	PP +filter paper+PP	50×20

Code	Description	Material	Packing
N219	Printed face mask, with earloops, one color printing	PP+filter paper+PP	50×20
N220	Printed face mask, with ties, one color printing	PP +filter paper+PP	50×20
N221	Printed face mask, with earloops, two colors printing	PP +filter paper+PP	50×20
N222	Printed face mask, with ties, two colors printing	PP +filter paper+PP	50×20

## Dust Mask - Máscara contra el polvo

Colors Available:  white  blue



Code	Description	Material	Packing
N213	Dust mask cone moulded	PP	50×20

## Beard Cover - Cubre Barba

Colors Available:  white  blue  green



Code	Description	Material	Packing
N207	Beard cover, with single loop	PP	100×10
N208	Beard cover, with double loops	PP	100×10



## Glove

- Vinyl Glove
- Creamy Vinyl Glove
- Nitrile Glove
- PE Glove
- PE Glove with long sleeve
- CPE Glove
- TPE Glove
- Latex Household Glove

## Guantes

- Guante de Vinilo
- Guante de Vinilo Cremoso
- Guante de Nitrilo
- Guante PE
- Guante PE con manga larga
- Guante CPE
- Guante TPE
- Guante de látex para el hogar

## Vinyl Glove

Colors Available:  clear  blue

### Guante de Vinilo



Feature: size: S/M/L/XL Grade:AQL 1.5, AQL2.5, AQL4.0

Característica: tamaño: S, M, L, XL Grado: AQL 1.5, AQL2.5, AQL4.0

Code	Description	Color	Material	Packing
G101	Vinyl gloves, powdered	Clear	Vinyl	100×10
G102	Vinyl gloves, powder free	Clear	Vinyl	100×10
G105	Vinyl gloves, powdered	Blue	Vinyl	100×10
G106	Vinyl gloves, powder free	Blue	Vinyl	100×10

## Creamy Vinyl Glove

Colors Available:  white  yellow

### Guante de Vinilo Cremoso



Feature: also called synthetic vinyl glove or Stretch vinyl glove

Característica: también llamado guante de vinilo sintético o de vinilo elástico

Code	Description	Color	Material	Packing
G109	Creamy vinyl glove, powdered	White	Vinyl	100×10
G110	Creamy vinyl glove, powder free	White	Vinyl	100×10
G111	Creamy vinyl glove, powdered	Yellow	Vinyl	100×10
G112	Creamy vinyl glove, powder free	Yellow	Vinyl	100×10

## Nitrile Glove

Colors Available:  white  blue  purple

### Guante de Nitrilo



Code	Description	Color	Material	Packing
G202	Nitrile gloves, powder free	Blue	Nitrile	100×10
G206	Nitrile gloves, powder free	White	Nitrile	100×10
G208	Nitrile gloves, powder free	purple	Nitrile	100×10

## PE Glove - Guante PE

Colors Available:  clear  blue



size: M, L, Embossed/Smooth Surface

Code	Description	Color	Material	Packing
C201	LDPE glove	Clear	LDPE	100×100
C202	LDPE glove	Blue	LDPE	100×100
C203	HDPE glove	Clear	HDPE	100×100
C204	2-fingers LDPE glove	Clear	LDPE	100×100
C207	PE glove, individual packing (2pcs/bag)	Clear	LDPE/HDPE	2×50×100



Code	Description	Color	Material	Packing
C210	PE glove, blocked	Clear	LDPE/HDPE	100×100
C208	PE glove, with paper head card	Clear	LDPE/HDPE	100×100

## PE Glove with long sleeve

Colors Available:  clear  blue  orange

### Guante PE con manga larga



## Veterinary glove - Guante Veterinario

Code	Description	Color	Material	Packing
C211	PE glove, length 35cm	Clear	LDPE	100×30
C212	PE glove, length 50cm	Blue	LDPE	100×30
C205	PE glove, length 90cm	Clear	LDPE	100×5
C215	PE glove, length 90cm, with elastic at opening	Clear	LDPE	100×5

## CPE Glove - Guante CPE

Colors Available:  clear  blue



Code	Description	Color	Material	Packing
C209	CPE glove	Clear/Blue	CPE	100×50
C216	Blocked CPE glove	Clear	CPE	100×50

## TPE Glove - Guante TPE

Colors Available:  clear  blue



Code	Description	Color	Material	Packing
C213	TPE glove	Clear	TPE	100×10

## Latex Household Glove

Colors Available:  blue  green  yellow  pink  red  orange

### Guante de látex para el hogar



Feature: Length: 300mm +/- 10mm, size: S, M, L, XL

Code	Description	Color	Packing
R104	Latex household glove, flocked, thickness: 0.04mm	Any color	1×12×12
R105	Latex household glove, flocked, thickness: 0.04mm	Bio-color (yellow&blue/yellow&green/red&black)	1×12×12
R106	Latex household glove, spray flocked, thickness: 0.035mm	Any color	1×12×12

Característica: Longitud: 300 mm +/- 10 mm, tamaño: S, M, L, XL



# Apron Delantal

- PE Apron
- T-Shirt Apron
- PVC Apron
- TPU Apron
- Nonwoven Apron
- Dental Bib

- Delantal PE
- Delantal tipo Camiseta
- Delantal de PVC
- Delantal de TPU
- Delantal no tejido
- Babero dental



## PE Apron - Delantal PE

Colors Available:  white  blue  green  clear  yellow  red  pink



Any size and thickness are available - Disponible en cualquier tamaño y grosor.

Code	Description	Material	Packing
C501	LDPE apron, flat packed	LDPE	100×10
C502	LDPE apron, flat packed in box	LDPE	100×10boxes
C503	HDPE apron, flat packed	HDPE	100×10

Code	Description	Material	Packing
C509	PE apron, blocked	LDPE/HDPE	50×10

Code	Description	Material	Packing
C505	LDPE apron on roll	LDPE	100×10
C504	HDPE apron on roll	HDPE	200×5

## PE Apron - Delantal PE

Colors Available:  white  blue  green  clear  yellow  
 red  pink



Code	Description	Material	Packing
C511	PE apron, with paper head card	LDPE+HDPE	50×10
C514	PE apron, with plastic head card	LDPE+HDPE	50×10

## T-Shirt Apron - Delantal tipo Camiseta

Colors Available:  white  blue



Code	Description	Material	Packing
N507	T-shirt apron	LDPE	50×5

## PVC Apron - Delantal de PVC

Colors Available:  white  blue



Code	Description	Thickness	Material	Packing
G501	PVC apron, economic type	80 microns	PVC	10×10
G502	PVC apron	300microns	PVC	1×25
G503	PVC apron	350 microns	PVC	1×25

## TPU Apron - Delantal de TPU

Colors Available:  white  blue



Code	Description	Thickness	Material	Packing
G521	TPU apron	300microns	TPU	1×25
G522	TPU apron	350microns	TPU	1×25
G523	TPU apron	400microns	TPU	1×25

## Nonwoven Apron - Delantal no tejido

Colors Available:  white  blue  green  yellow



Code	Description	Material	Packing
N501	Nonwoven apron	PP	10×20
N502	PE coated nonwoven apron	PP+PE	10×20

## Dental Bib - Babero delantal

Colors Available:  white  blue  green  yellow  red  pink  purple



Code	Description	Material	Packing
N503	Paper dental bib without tie, 1ply, all colors	1ply Paper +PE	125×4
N504	Paper dental bib without tie, 2ply, all colors	2ply Paper +PE	125×4
N505	Paper dental bib with paper ties, with pocket	1ply Paper +PE	100×10
N508	Paper dental bib with paper ties, without pocket	1ply Paper +PE	100×10



## Sleeve Cover and Shoe Cover

- Sleeve Cover
- CPE Shoe Cover
- PE Shoe Cover
- PP+CPE Shoe Cover
- Nonwoven Shoe Cover
- Non-skid PP Shoe Cover
- Nonwoven Sock Cover
- PE coated PP Shoe Cover
- Microporous Shoe Cover
- Boot Cover

## Cubre Manga y Cubre Zapatos

- Cubre Manga
- Cubre Zapato CPE
- Cubre Zapato PE
- Cubre Zapato PP + CPE
- Cubre Zapato no tejido
- Cubre Zapato PP antideslizante
- Cubre Calcetín no tejido
- Cubre Zapato PP recubierto PE
- Cubre Zapato Microporoso
- Cubre Bota

# Sleeve Cover- Cubre Manga

Colors Available:  white  blue  green  yellow  red



Code	Description	Material	Packing
C601	Sleeve cover, hand made	PE	100×20
C602	Sleeve cover, machine made	PE	100×20

Code	Description	Material	Packing
N601	Nonwoven sleeve cover	PP	100×10
N602	PE coated nonwoven sleeve cover	PP+PE	100×10

Code	Description	Material	Packing
G510	PVC sleeve cover, economic type	80 microns	10×20
G511	PVC sleeve cover	300 microns	10×20

## CPE Shoe Cover- Cubre Zapato CPE

Colors Available:  white  blue  green



## PE Shoe Cover Cubre Zapato PE

Colors Available:  white  blue  green



## PP+CPE Shoe Cover Cubre Zapato PP + CPE

Colors Available:  white  blue  brown



Any size and thickness are available - Disponible en cualquier tamaño y grosor.

Code	Description	Material	Packing
C401	CPE shoe cover, hand made	CPE	100×20
C405	CPE shoe cover, machine made	CPE	100×20
C408	CPE shoe cover individual packing 2pcs per bag	CPE	2×50×20
C416	CPE shoe cover, individual packing 2pcs per capsule	CPE	2×50×20

Code	Description	Material	Packing
C406	PE shoe cover, hand made	PE	100×40
C407	PE shoe cover, machine made	PE	100×40

Code	Description	Material	Packing
N404	PP+CPE shoe cover, white+ blue	PP+CPE	100×10

## Nonwoven Shoe Cover Cubre Zapato no tejido

Colors Available:  white  blue  green



## Non-skid PP Shoe Cover Cubre Zapato PP antideslizante

Colors Available:  white  blue  green



## Nonwoven Sock Cover Cubre Calcetín no tejido

Colors Available:  white  blue  green



Code	Description	Material	Packing
N401	Nonwoven shoe cover	PP	100×10

Code	Description	Material	Packing
N402	Non-skid PP shoe cover	PP	100×10

Code	Description	Material	Packing
N405	Nonwoven sock cover, individual packing	PP	2×50×40
N408	Nonwoven sock cover, bulk packing	PP	100×40

## PE coated PP Shoe Cover Cubre Zapato PP recubierto PE

Colors Available:  white  blue  purple



## Microporous Shoe Cover Cubre Zapato Microporoso

Colors Available:  white



## Boot Cover Cubre Bota

Colors Available:  white  blue  clear



Code	Description	Material	Packing
N403	PE coated PP shoe cover	PE coated PP	100×10
N418	CPE coated PP shoe cover	CPE coated PP	100×10

Code	Description	Material	Packing
N419	Microporous shoe cover	PE laminated nonwoven	100×10

Code	Description	Size	Material	Packing
C409	PE boot cover	38×40cm	LDPE	100×5
C410	PE boot cover	38×47cm	LDPE	100×5



## Otros Productos No tejidos

Tanga/Zunga  
Bragas  
Guante de lavado  
Capucha para silla  
Sábana  
Cubierta de cama  
Cubierta PE  
Hoja de papel con revestimiento PE

## Other Nonwoven Products

G-String  
Briefs  
Washing Glove  
Chair Hood  
Bed Sheet  
Bed Cover  
PE Cover  
Paper Sheet with PE coated



## G-String - Tanga/Zunga

Colors Available:  white  dark blue



Code	Description	Material	Packing
N803	G-string for women	PP	1×50×10
N804	G-string for men	PP	1×50×10

## Briefs - Bragas

Colors Available:  white  dark blue  black  printed



Code	Description	Material	Packing
N802	Briefs for both men & women	PP	1×50×10
N811	Briefs for men	PP	1×50×10
N812	Briefs for women	PP	1×50×10
N807	Briefs for both men & women, super soft	Super soft PP	1×50×10
N808	Briefs, super soft, with one color printing	Super soft PP	1×50×10

## Bed Sheet - Sábana

Colors Available:  white  blue  green



Code	Description	Material	Packing
N701	Nonwoven bed sheet, any size	PP	10×10
N706	Nonwoven bed sheet on roll, with perforation	PP	200pcs per roll
N703	PE coated PP bed sheet	PP+PE	10×10

## Pillow Case - Funda de Almohada

Colors Available:  white  blue  green



Code	Description	Material	Packing
N707	Pillow case	PP	10×20
N708	Pillow case with slip	PP	10×20

## Washing Glove - Guante de lavado

Colors Available:  white



Code	Description	Material	Packing
N904	Washing glove	Needle punched cotton	50×20
N905	Washing glove	Spunlace	50×20
N906	Washing glove	Air-Laid paper	50×20

## Chair Hood - Capucha de Silla

Colors Available:  white



Code	Description	Material	Packing
N903	Nonwoven chair hood, with velcro, with printing	PP	50×500

## PE Cover - Cubierta PE

Colors Available:  blue



Code	Description	Size	Material	Packing
C704	CPE mattress cover	210×90×20cm	CPE	10×20
C713	PE tray cover	85×125×25cm	LDPE	10×20
C714	PE tray cover	105×125×25cm	LDPE	10×20
C701	PE sheet	Any size	LDPE	10×20
N704	Bed sheet, with elastic at 2 ends		PP	10×10
N705	Bed sheet, with elastic at 4 corners		PP	10×10

## Paper Sheet with PE coated

Colors Available:  blue  white

### Hoja de Papel con Revestimiento PE



Code	Description	Material	Packing
N716	Paper sheet, with PE coated	Paper+PE	50×4
N717	Sterile paper sheet, with PE coated individual packing	Paper+PE	1×200
N718	Paper roll, with PE coated with perforation	Paper+PE	100m/roll
N719	Paper sheet, with PE coated with thread	Paper+PE	25×4



## Surgical Gown

Surgical Gown  
Doctor Set

## Bata Quirúrgica

Bata Quirúrgica  
Set para Doctor

## Surgical Gown - Bata Quirúrgica

Colors Available: ● blue ● dark blue ● green



Feature: Sterilized by EO, individual paper pouch packing Velcro at neck with 4 waist belts, cotton cuffs, Any other specifications are available on request.

<b>Code</b>	N306-U1
<b>Description</b>	Sterile surgical gown, standard, with hand towel
<b>Size</b>	S-XXL
<b>Material</b>	SMS / SMMS / SMMMS
<b>Packing</b>	1×30

<b>Code</b>	N306-U3
<b>Description</b>	Sterile surgical gown, reinforced at chest and half sleeve, with hand towel
<b>Size</b>	S-XXL
<b>Material</b>	SMS / SMMS / SMMMS
<b>Packing</b>	1×30

<b>Code</b>	N306-U4
<b>Description</b>	Sterile surgical gown, reinforced at full chest and full sleeve, with hand towel
<b>Size</b>	S-XXL
<b>Material</b>	SMS / SMMS / SMMMS
<b>Packing</b>	1×30

Característica: Esterilizado por EO, bolsa de papel individual con velcro en el cuello con 4 cinturones, puños de algodón. Cualquier otra especificación está disponible a pedido.

## Surgical Gown - Bata Quirúrgica

Colors Available: ● blue ● dark blue ● green



<b>Code</b>	N309
<b>Description</b>	Spunlace Surgical gown, standard, with hand towel
<b>Size</b>	S-XXL
<b>Material</b>	Pulp Spunlace
<b>Packing</b>	1×30

## Doctor Set - Set para Doctor

Colors Available: ● blue ● dark blue ● green



<b>Code</b>	N3171	N333	N334
<b>Description</b>	Doctor set, Regular style	SMS T-shirt	SMS pant, with string or elastic at waist
<b>Size</b>	S-XXL	S-XXL	S-XXL
<b>Material</b>	SMS	SMS	SMS
<b>Packing</b>	1×50	10×5	10×5



<b>Code</b>	N3170
<b>Description</b>	Doctor set, Simple style
<b>Size</b>	S-XXL
<b>Material</b>	SMS
<b>Packing</b>	1×50



## Paño Quirúrgico y Sets

- Paquete Básico
- Paquete Universal
- Paquete de Laparotomía
- Paquete de Cesárea
- Paquete de Entrega
- Paquete Ortopédico
- Paquete de Ojos
- Paquete Dental
- Paquete de Artroscopia
- Paquete de Extremidades
- Paquete de Angiografía
- Paño Quirúrgico

## Surgical Drape and Pack

- Basic Pack
- Universal Pack
- Laparotomy Pack
- C-Section Pack
- Delivery Pack
- Orthopedic Pack
- Eye Pack
- Dental Pack
- Arthroscopy Pack
- Extremity Pack
- Angiography Pack
- Surgical Drape

# Fabric - Tela:



Fabric Picture:  
Imagen de nuestras telas:



Our fabric conforms to EN13795 / Nuestras telas cumplen con los estándares EN13795



## Basic Pack 001 N7600-001 Paquete Básico 001

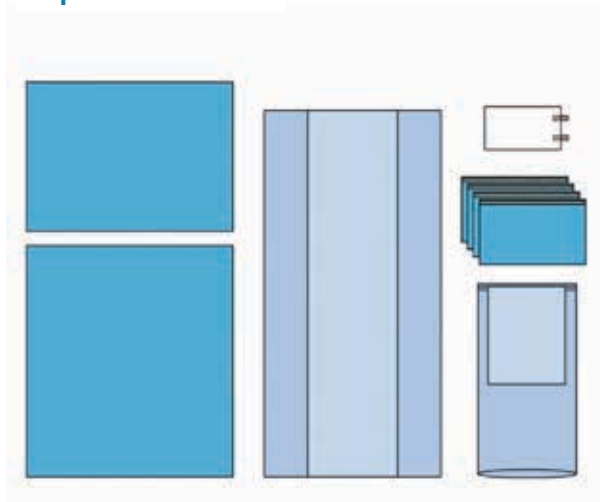

## Basic Pack 002 N7600-002 Paquete Básico 002

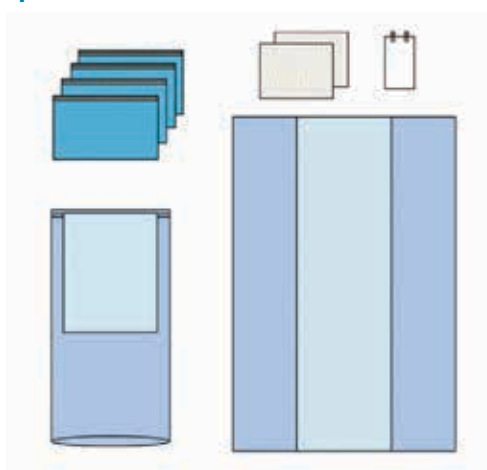

Specification	Size (cm)	Qty
Table Cover	150x200 (75x200)	1
Mayo Stand Cover	58x137 (48x60)	1
Utility Drape with Adhesive	38x66	4
Drape Sheet	105x150	1
Drape Sheet	150x160	1
Suture Bag	16x28	1

1pc/pouch, 16 pouches/ctn  
1 unidad/bolsa, 16 bolsas/caja

All the pack can be customized  
Todo el paquete se puede personalizar

Specification	Size (cm)	Qty
Table Cover	140x210 (60x210)	1
Mayo Stand Cover	58x137 (48x60)	1
Utility Drape	38x66	4
Suture Bag	16x28	1
Hand Towel	30x40	2

1pc/pouch, 32 pouches/ctn  
1 unidad/bolsa, 32 bolsas/caja

All the pack can be customized  
Todo el paquete se puede personalizar

**Universal Pack 001**  
**Paquete Universal 001**

N7601-001

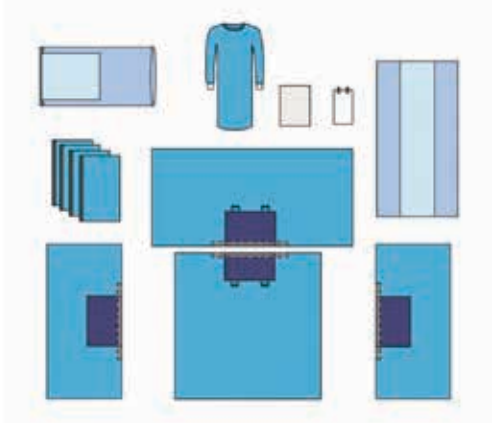

**Universal Pack 001 - Paquete Universal 001** N7601-001

Specification	Size (cm)	Qty
Table Cover	140x210 (60x210)	1
Mayo Stand Cover	58x137 (48x60)	1
Standard SMS Gown L	125x145	1
Utility Drape with Adhesive	38x66	4
Side Drape Reinforced ,with Adhesive	196x94 (64x43)	2
Head Drape Reinforced ,with Adhesive	249x135 (64x38)	1
Foot Drape Reinforced ,with Adhesive	188x180 (64x38)	1
Suture Bag	16x28	1
Hand Towel	30x40	1

1pc/pouch, 6 pouches/ctn All the pack can be customized  
1 unidad/bolsa, 6 bolsas/caja Todo el paquete se puede personalizar

**Universal Pack 002**  
**Paquete Universal 002**

N7601-002

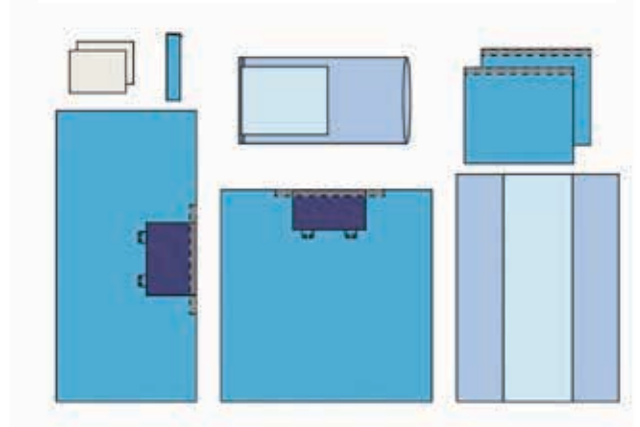

Specification	Size (cm)	Qty
Table Cover	150x200 (75x200)	1
Mayo Stand Cover	76x145 (48x60)	1
Top Drape Reinforced ,with Adhesive	180x240 (38x64)	1
Side Drape	100x90	2
Bottom Drape Reinforced ,with Adhesive	180x180 (38x64)	1
Tape Strip (op-tape)	10x50	1
Hand Towel	30x40	2

1pc/pouch, 12 pouches/ctn All the pack can be customized  
1 unidad/bolsa, 12 bolsas/caja Todo el paquete se puede personalizar

**Laparotomy Pack 001**  
**Paquete de Laparotomía 001**

N7602-001

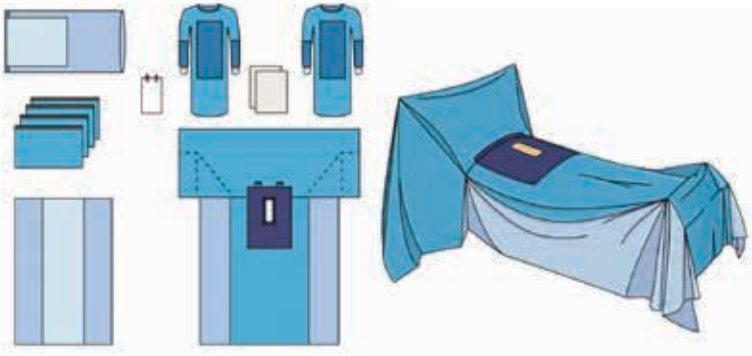

**Laparotomy Pack 001 - Paquete de Laparotomía 001** N7602-001

Specification	Size (cm)	Qty
Table Cover	140x210 (60x210)	1
Mayo Stand Cover	58x137 (48x60)	1
SMS Reinforced Gown, L	125x145	2
Utility Drape with Adhesive	38x66	4
Laparotomy Drape	254(196)x 305	1
Suture Bag	16x28	1
Hand Towel	30x40	2

1pc/pouch, 8 pouches/ctn All the pack can be customized  
1 unidad/bolsa, 8 bolsas/caja Todo el paquete se puede personalizar

**Laparotomy Pack 002**  
**Paquete de Laparotomía 002**

N7602-002

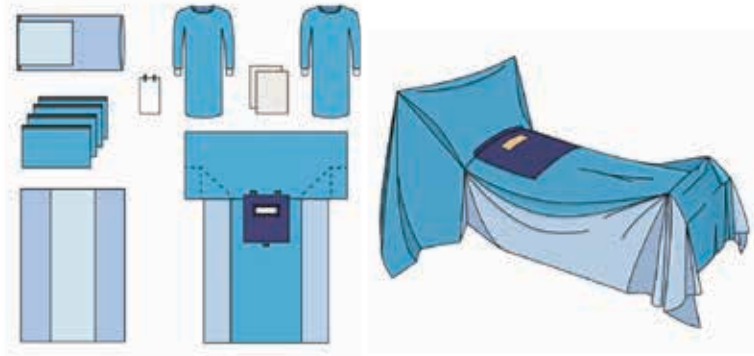

**Laparotomy Pack 002 - Paquete de Laparotomía 002** N7602-002

Specification	Size (cm)	Qty
Table Cover	140x210 (60x210)	1
Mayo Stand Cover	58x137 (48x60)	1
Standard SMS Gown L	125x145	2
Utility Drape with Adhesive	38x66	4
Laparotomy Drape	267(196) x353	1
Suture Bag	16x28	1
Hand Towel	30x40	2

1pc/pouch, 6 pouches/ctn All the pack can be customized  
1 unidad/bolsa, 6 bolsas/caja Todo el paquete se puede personalizar

## C-Section Pack 001 Paquete de Cesárea

N7603-001

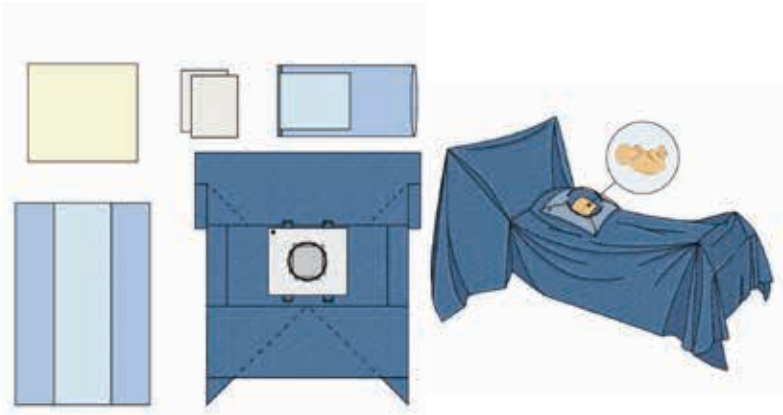

Specification	Size (cm)	Qty
Table Cover	140x210 (60x210)	1
Mayo Stand Cover	78x145 (48x60)	1
C-Section Drape , with Liquid Pouch	252x281	1
Baby Drape	90x80	1
Hand Towel	30x40	2

1pc/pouch, 7 pouches/ctn All the pack can be customized  
1 unidad/bolsa, 7 bolsas/caja Todo el paquete se puede personalizar

## Delivery Pack 001 Paquete de Parto

N7604-001

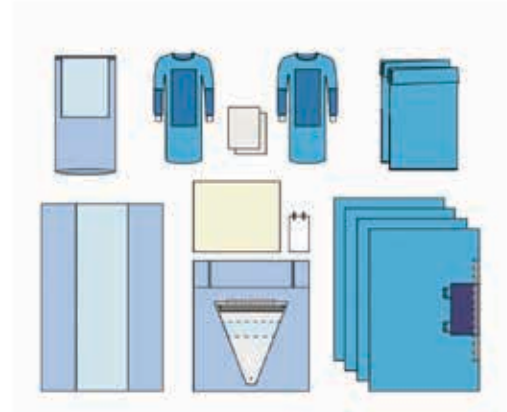

Specification	Size (cm)	Qty
Table Cover	140x190 (60x190)	1
Mayo Stand Cover	58x137 (48x60)	1
SMS Reinforced Gown, L	125x145	2
Adhesive Drape with Reinforcement	100x150 (23x40)	4
Under Buttock Drape with Liquid Pouch	102x112	1
Leggings	80x120	2
Suture Bag	16x28	1
Baby Drape	90x75	1
Hand Towel	30x40	2

1pc/pouch, 8 pouches/ctn All the pack can be customized  
1 unidad/bolsa, 8 bolsas/caja Todo el paquete se puede personalizar

## Orthopedic Pack 001 Paquete Ortopédico 002

N7605-001

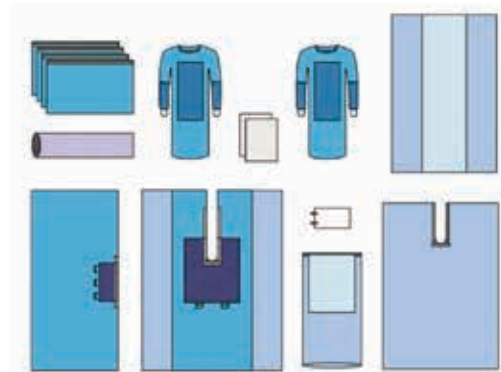

Specification	Size (cm)	Qty
Table Cover	140x210 (60x210)	1
Mayo Stand Cover	58x137 (48x60)	1
SMS Reinforced Gown, L	125x145	2
Utility Drape with Adhesive	38x66	4
PE Split Drape	152x213	1
Split Drape	196x250	1
Top Drape	135x251	1
Suture Bag	16x28	1
Stockinette	23x122	1
Hand Towel	30x40	2

1pc/pouch, 8 pouches/ctn All the pack can be customized  
1 unidad/bolsa, 8 bolsas/caja Todo el paquete se puede personalizar

## Orthopedic Pack 002 Paquete Ortopédico 002

N7605-002

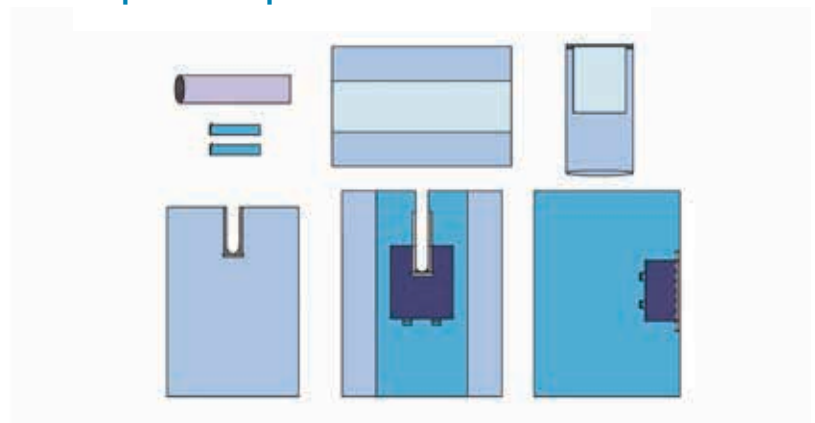

Specification	Size (cm)	Qty
Table Cover	140x210 (60x210)	1
Mayo Stand Cover	58x137 (48x60)	1
PE Split Drape	150x180	1
Split Drape Split	200x300	1
Top Drape	240x180	1
Stockinette	23x122	1
Tape Strip	10x50	2

1pc/pouch, 10 pouches/ctn All the pack can be customized  
1 unidad/bolsa, 10 bolsas/caja Todo el paquete se puede personalizar

**Eye Pack 001**  
**Paquete de Ojos 001**

N7606-001

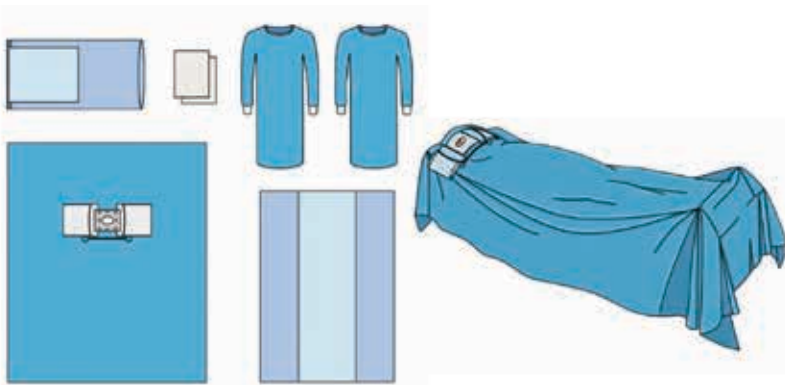

Specification	Size (cm)	Qty
Table Cover	140x210 (60x210)	1
Mayo Stand Cover	58x137 (48x60)	1
Standard SMS Gown L	125x145	2
Eye Drape , with Liquid Pouch, Inoise Tape	150x180	1
Hand Towel	30x40	2

1pc/pouch, 16 pouches/ctn      All the pack can be customized  
1 unidad/bolsa, 16 bolsas/caja      Todo el paquete se puede personalizar

**Dental Pack 001**  
**Paquete Dental 001**

N7607-001

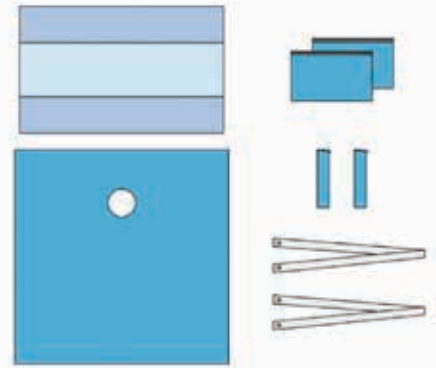

Specification	Size (cm)	Qty
Table Cover	140x210 (60x210)	1
Utility Drape	38x66	2
Tape Strip (op-tape)	10x50	2
Dental Drape	150x150	1
Tube cover	8x120	2

1pc/pouch, 32 pouches/ctn      All the pack can be customized  
1 unidad/bolsa, 32 bolsas/caja      Todo el paquete se puede personalizar

**Arthroscopy Pack 001**  
**Paquete de Artroscopia 001**

N7608-001

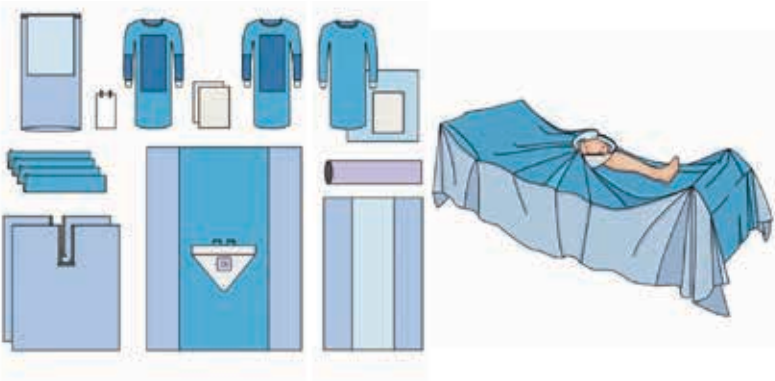

Specification	Size (cm)	Qty
Table Cover	140x210 (60x210)	1
Mayo Stand Cover	58x137 (48x60)	1
Standard SMS Gown L, with Towel in Wrap	125x145	1
SMS Reinforced Gown, L	125x145	2
PE Spill Drape	152x178	2
Arthroscopy Drape, with Liquid Pouch	230x300	1
Suture Bag	16x28	1
Tape Strip (op-tape)	10x50	4
Stockinette	23x122	1
Hand Towel	30x40	2

1pc/pouch, 6 pouches/ctn      All the pack can be customized  
1 unidad/bolsa, 6 bolsas/caja      Todo el paquete se puede personalizar

**Extremity Pack 001**  
**Paquete de Extremidades 001**

N7609-001

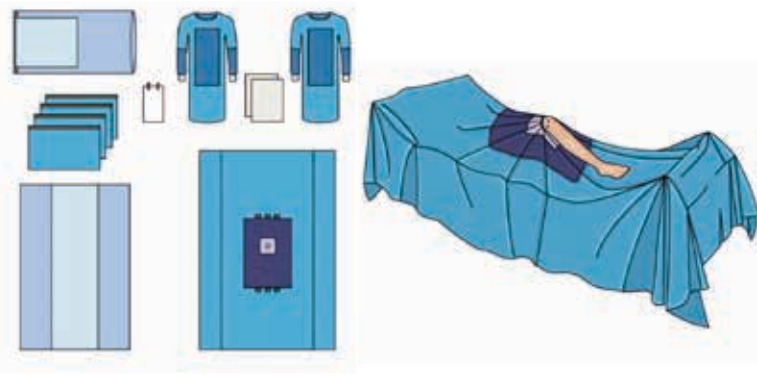

Specification	Size (cm)	Qty
Table Cover	140x210 (60x210)	1
Mayo Stand Cover	58x137 (48x60)	1
SMS Reinforced Gown, L	125x145	2
Utility Drape with Adhesive	38x66	4
Extremity Drape	220x318	1
Suture Bag	16x28	1
Hand Towel	30x40	2

1pc/pouch, 9 pouches/ctn      All the pack can be customized  
1 unidad/bolsa, 9 bolsas/caja      Todo el paquete se puede personalizar



## Angiograph Pack 001 Paquete de Angiografía 001

N7610-001

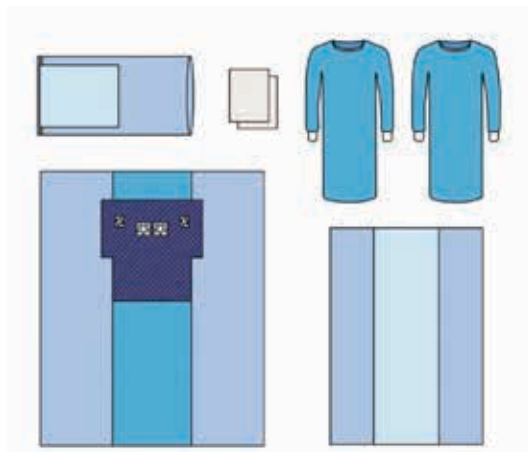

## Angiograph Pack 002 Paquete de Angiografía 002

N7610-002

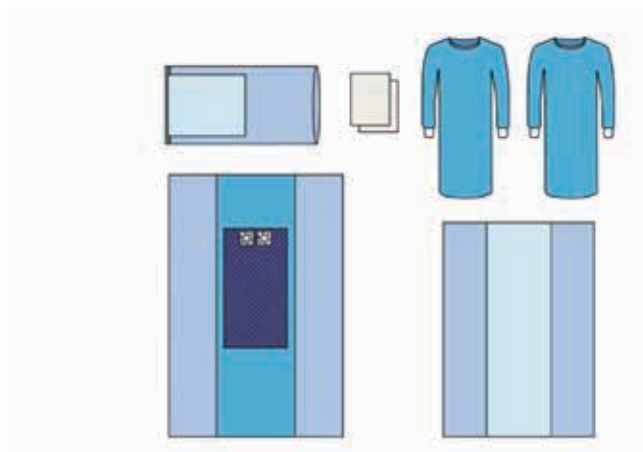

Specification	Size (cm)	Qty
Table Cover	140x210 (60x210)	1
Mayo Stand Cover	58x137 (48x60)	1
Standard SMS Gown L	125x145	2
Angiography Drape	310x380	1
Hand Towel	30x40	2

1pc/pouch, 9 pouches/ctn  
1 unidad/bolsa, 9 bolsas/caja

All the pack can be customized  
Todo el paquete se puede personalizar

Specification	Size (cm)	Qty
Table Cover	140x210 (60x210)	1
Mayo Stand Cover	58x137 (48x60)	1
Standard SMS Gown L	125x145	2
Angiography Drape	220x330	1
Hand Towel	30x40	2

1pc/pouch, 9 pouches/ctn  
1 unidad/bolsa, 9 bolsas/caja

All the pack can be customized  
Todo el paquete se puede personalizar

## Surgical Drape - Paño Quirúrgico

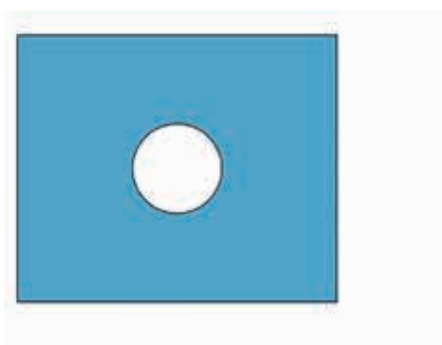

**Standard Drape** SMS/PP+PE film / Viscose + PE film  
1pc/pouch, sterilized by EO

Ref.	Size(cm)	Pieces per ctn
N7210-1	40x60	200
N7210-2	50x75	200
N7210-3	75x75	200
N7210-4	75x90	100
N7210-5	100x150	100
N7210-6	110x190	100
N7210-7	150x200	50

**Paño Estándar**  
SMS/PP+ Película PE/Viscosa + Película PE  
1 unidad/bolsa, esterilizado por OE

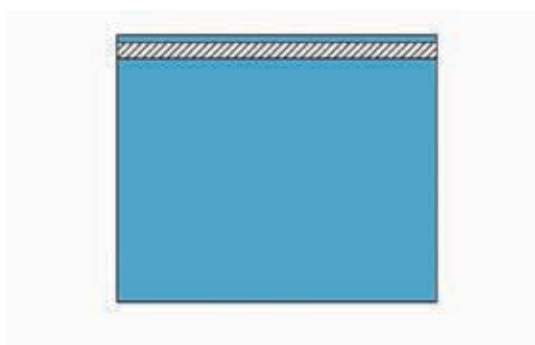

**Drape with Adhesive Side** SMS/PP+PE film  
1pc/pouch, sterilized by EO

Ref.	Size(cm)	Pieces per ctn
N7310-1	40x60	200
N7310-2	50x75	200
N7310-3	75x75	200
N7310-4	75x90	100
N7310-5	100x150	100
N7310-6	110x190	50
N7310-7	150x200	50

**Paño con lado Adhesivo**  
SMS/PP+ Película PE  
1 unidad/bolsa, esterilizado por OE

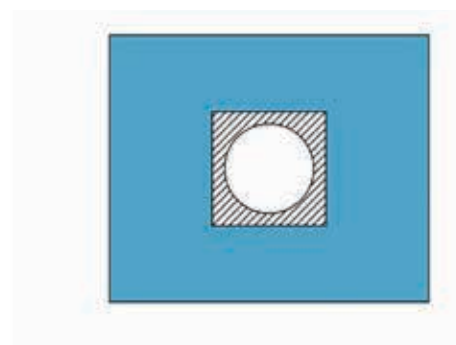

**Drape with Adhesive Aperture** SMS/PP+PE film  
1pc/pouch, sterilized by EO

Ref.	Size(cm)	Aperture ø (cm)	Pieces per ctn
N7311-1	40x60	6	200
N7311-2	50x75	6	200
N7311-3	75x75	6	200
N7311-4	75x90	6x8	100
N7311-5	100x150	5x7	100
N7311-6	150x200	6x15	50
N7311-7	200x240	12	30

**Paño con Abertura Adhesiva**  
SMS/PP+ Película PE  
1 unidad/bolsa, esterilizado por OE



[www.ITMbusinessSolutions.ca](http://www.ITMbusinessSolutions.ca)

[Ventas@ITMbusinessSolutions.ca](mailto:Ventas@ITMbusinessSolutions.ca)    [sales@ITMbusinessSolutions.ca](mailto:sales@ITMbusinessSolutions.ca)

P: 1-604-295-3922